

version .0

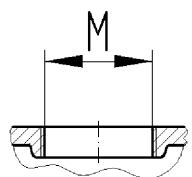

version .1

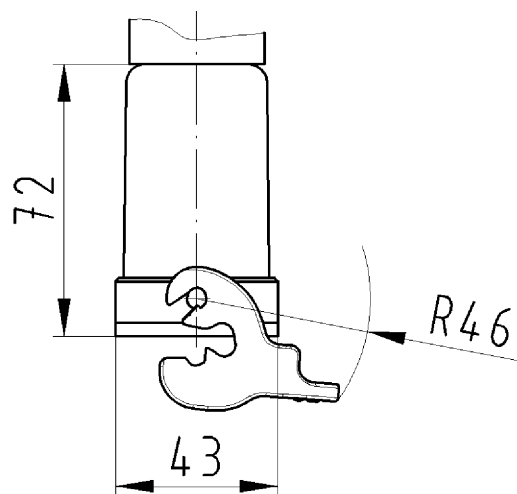
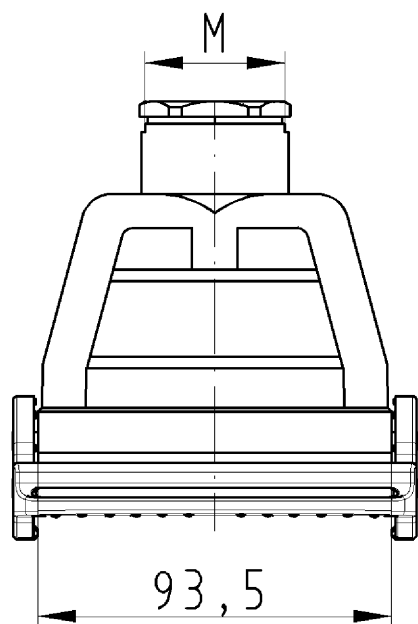
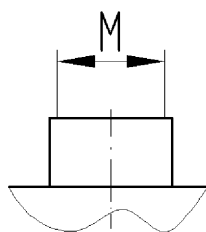

version .2

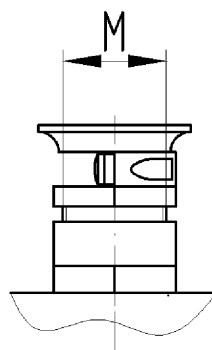

version .3

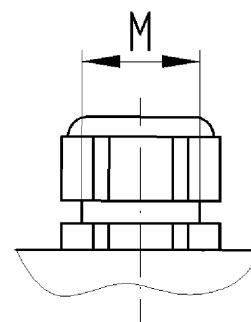

version .5

IP 65

Gehäuseoberteil
71.372.1635.0

Zeichnungsnummer
71.372.1635.010W
Gehäuseoberteil

12.12.2007
Hoffmann Angelika
M 1:2